

THIS DRAWING AND SPECIFICATION ARE PROPERTY OF MAGER S.p.A. AND MUST NOT BE REPRODUCED OR COPIED OR USED IN WHOLE OR IN PART WITHOUT WRITTEN PERMISSION FROM MAGER

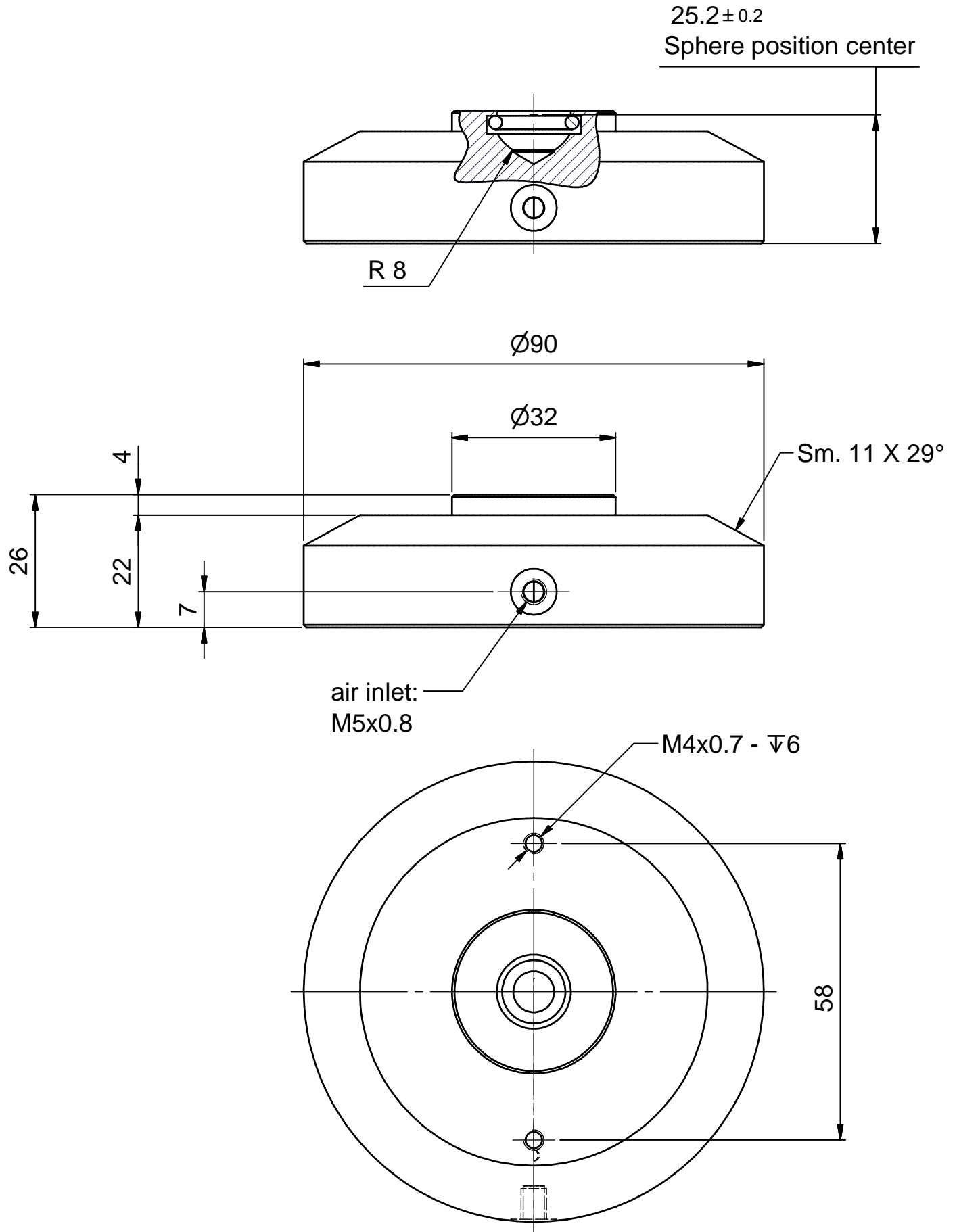

MAGER s.r.l.
air bearings

HPC3.0 D090x26.0 A-OI08.0-I3M5-3M4-00

CODICE
WF10200P07000

MODIFICA

UNITA' DIM.
mm

MASSA
0,355 kg

SCALA
1:1

