

THIS DRAWING AND SPECIFICATION ARE PROPERTY OF MAGER S.p.A. AND MUST NOT BE REPRODUCED OR COPIED OR USED IN WHOLE OR IN PART WITHOUT WRITTEN PERMISSION FROM MAGER

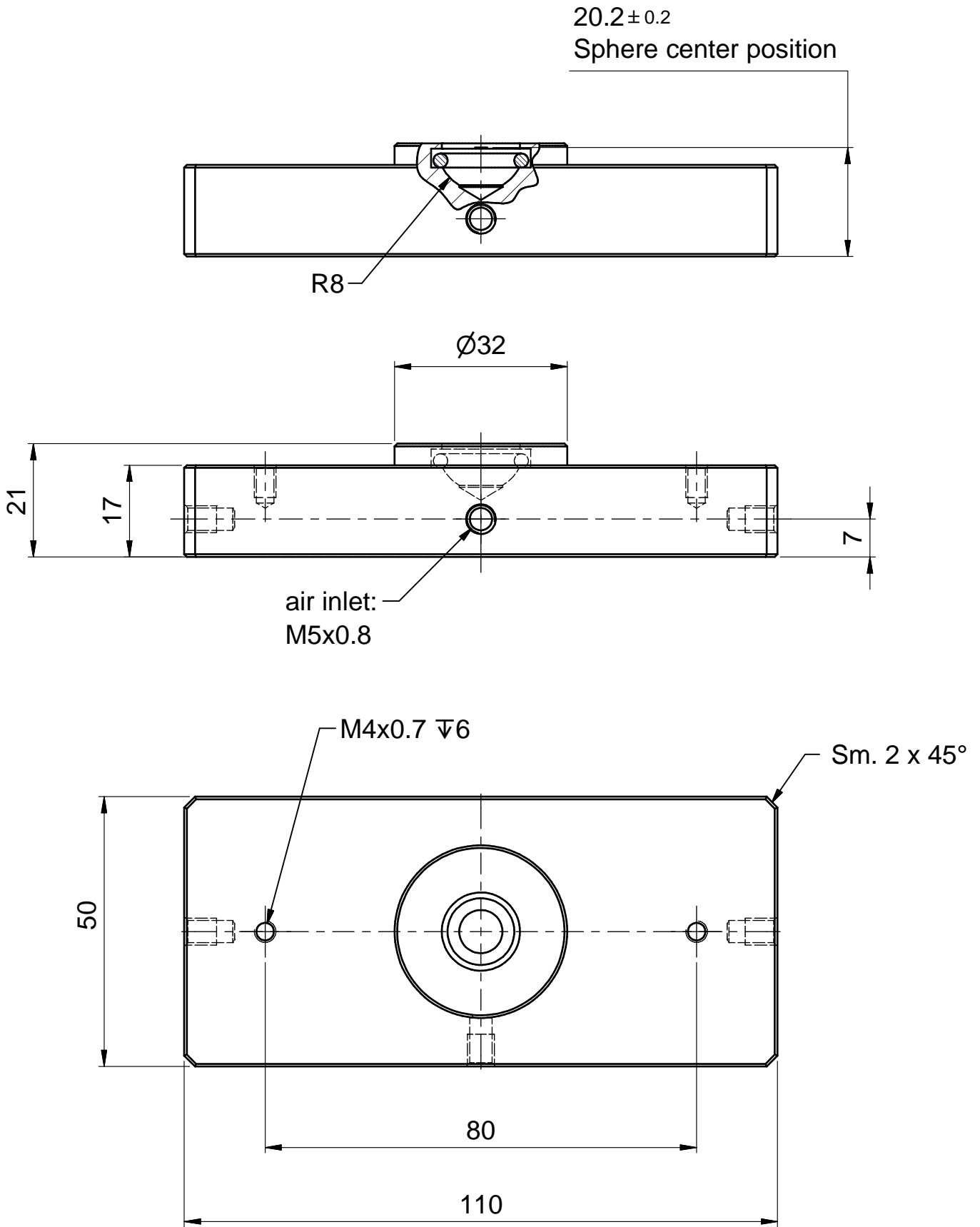

MAGER s.r.l.
air bearings

HPR3.2 050x110x21.0A-OI08.0-I3M5-2M4-00

CODICE
WF10100P10000

MODIFICA

UNITA' DIM.
mm

MASSA
0,254 kg

SCALA
1:1

