

M5x0.8  $\nabla$ 6  
\* PRESSURE PORT

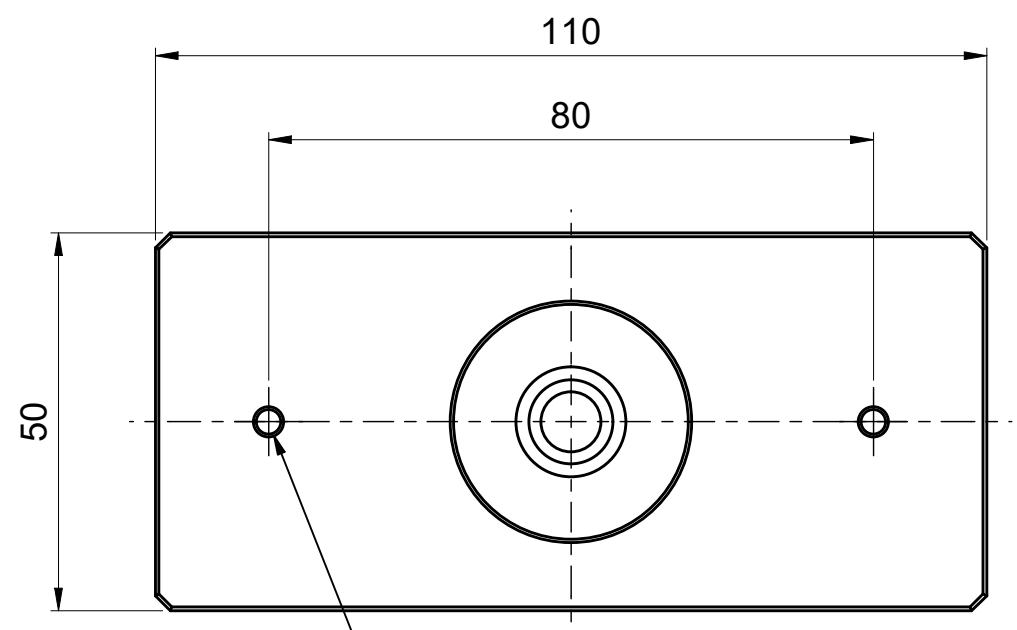

2x M4x0.7  $\nabla$ 4  
THREADED HOLE  
FOR COUNTER ROTATION PIVOT

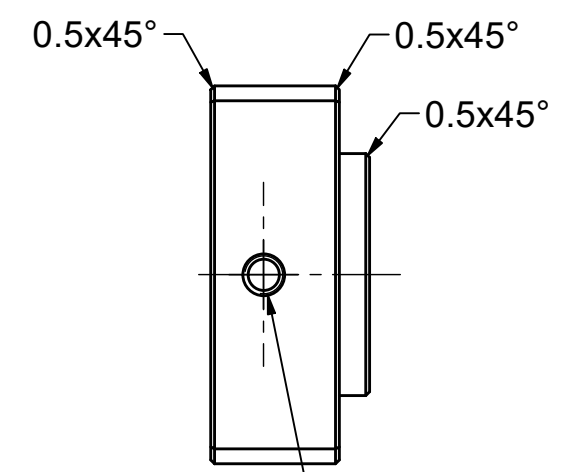

M5x0.8  $\nabla$ 6  
\* PRESSURE PORT

\* NOTE:  
The air bearings are supplied with the pressure ports closed  
Remove the relative taps before use according to the pneumatic connection needs (series or parallel)

GENERAL TOLERANCES - FOR FEATURES WITHOUT SPECIFIC TOLLERANCE INDICATION ACCORDING TO ISO 2768 - mH					
GENERAL TOLERANCES FOR THREADS ISO 965-1 GAS ISO 228/1					
	HPR3.2 FLAT RECTANGULAR AIR BEARING 050x110x21				RELEASE DATE
	A-OI08.0-I3M5-2M4-00 [C1]				09/12/2020
CODE	RELEASE	MEAS.UNIT	MASS	SCALE	
WF10100P10000	A	mm	0,279 kg	1:1	

This drawing contains information which are property of Mager srl.  
Any total or partial reproduction, disclosure, copy or use of this drawing or the information contained herein is expressly prohibited without prior written permission from Mager srl.  
MAGER reserves also the right to change or update his products at its sole discretion at any time and without further notice.